

Part No. 12279  
Revised April 2002

# Hawaii's Finest

## Ice Shaver Instruction Manual







Model #1047



 **GOLD MEDAL**<sup>®</sup>  
FUNFOOD EQUIPMENT & SUPPLIES

Cincinnati, OH 45241-4807 USA

# SAFETY PRECAUTIONS

	<p style="text-align: center;"><b>⚠ DANGER</b></p> <p>Machine must be properly grounded to prevent electrical shock to personnel. Do not immerse the equipment in water. Keep cord and plug off the ground, and away from moisture. Always unplug the equipment before cleaning or servicing.</p>
	<p style="text-align: center;"><b>⚠ WARNING</b></p> <p>Never put your fingers or any object into the shaver body (the goose-neck) while the motor is running. Serious injury may occur. <i>(Gold Medal Products does not assume any liability for injury due to careless handling and/or reckless operation of this equipment).</i></p>
	<p style="text-align: center;"><b>⚠ WARNING</b></p> <p>ALWAYS wear safety glasses when servicing this equipment.</p>
	<p style="text-align: center;"><b>⚠ WARNING</b></p> <p>Any alterations to this equipment will void the warranty and may cause a dangerous situation. NEVER make alterations to the equipment. Make sure all machine switches are in the off position before plugging the equipment into the receptacle.</p>
	<p style="text-align: center;"><b>⚠ CAUTION</b></p> <p>Do NOT allow direct contact with this equipment and the general public when used in food service locations. Only personnel that are trained and familiar with the equipment should operate the equipment. Carefully read all installation instructions before operation.</p>
	<p style="text-align: center;"><b>⚠ CAUTION</b></p> <p>This machine is NOT to be operated by minors. Minors are classified as anyone under the age of 18.</p>

## NOTE

The information, specifications and illustrations contained in this manual represent the latest data available at time of publication. Right is reserved to make changes as required at the discretion of Gold Medal Products Company without notice.

## SPECIAL FEATURES

1. Model 1047 uses cubed ice.
2. Snow texture can be adjusted easily with adjustment knob.
3. Blade is easily removable for replacement.
4. Safety switch is installed in loading lid, preventing motor from operating while lid is open.
5. Thermal protected motor, with remotely mounted reset button.

## SPECIFICATIONS

Dimensions: 31" high (lid open) x 18" wide x 21" deep.

Net weight: 80 pounds.

Motor: 120 Volts, 12.8 Amps max., 60Hz.

Accessories: Foot switch.

## INSTALLATION

1. Be sure to connect electrical plug to a grounded receptacle only.
2. Leave enough room in the back of machine to allow hookup of drain hose. Dump unused ice and water from drain hose to floor drain or basin tub. Drain water from hose is not intended for human consumption!
3. Be sure unit is on table that is sturdy and can withstand accidental dripping of water and ice.

## USING YOUR MACHINE

1. Allow ice to soften at least (1) hour in a ice cooler before use, using ice straight from the freezer effects the quality of the shaved ice as well as it could damage the shaver blade.
2. Lift cover lid and load ice cubes to 1/2" of top, close lid. Be sure ice is loaded evenly in each cavity. Place cup directly below ice chute and turn power "ON". **NOTE:** Failure to close lid will cause machine not to operate!
3. Adjust blade height with adjustment knob to achieve the preferred ice texture.
4. To stop, turn power switch to "OFF" position. **NOTE:** Should the motor thermal protector trip (the motor stops despite machine being plugged in and the power switch in the "ON" position), reset by pushing the red button. It is recommended the cause of over load be found and eliminated before continuing. The machine may need to cool a bit before the reset button may take effect.

## CLEANING INSTRUCTIONS



1. Remove lid by removing the wingnut and hinge pin.
2. Remove four plastic button screws that hold top hopper cover, and lift and roll over. Disconnect wire harness at plug.  
**NOTE:** When reinstalling cover, you **MUST** reconnect plug!
3. Remove three thumb screws and remove impeller cover.
4. Remove impeller knob, and lift impeller off. For removal of Impeller Knob a screwdriver slot is supplied on bottom end of motor.
5. Lift off bottom plastic base cover.
6. Remove two stainless steel button screws holding chute.
7. Wipe down all easily accessible areas with a clean, dry cloth. (Do not use cleaners that are ammonia based).

## TO REMOVE BLADE AND BLADE HOLDER

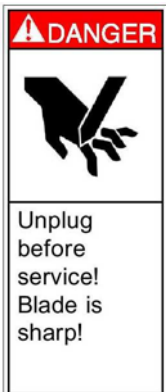

1. Blade holder should be cleaned at weekly intervals. Begin removal by removing chute.
2. Using blade adjustment knob, unscrew blade adjustment shaft and remove.
3. Pull pivot pin out completely.
4. Blade, blade holder assembly and spring are now free for removal.
5. Remove three readily removable blade retainers and remove blade.
6. Wipe area and parts with clean, dry cloth.
7. Assemble in opposite order as above.

# MAINTENANCE INSTRUCTIONS

	<b>⚠ CAUTION</b>
	THE FOLLOWING SECTIONS OF THIS MANUAL ARE INTENDED ONLY FOR QUALIFIED SERVICE PERSONNEL WHO ARE FAMILIAR WITH ELECTRICAL EQUIPMENT. THESE ARE NOT INTENDED FOR THE OPERATOR.

	<b>⚠ WARNING</b>
	Adequate eye protection must be used when servicing this equipment to prevent the possibility of injury.

	<b>⚠ DANGER</b>
	Do NOT immerse the equipment in water. Unplug your machine before servicing.

## ORDERING SPARE PARTS



1. Identify the desired part by checking it against the photos, illustrations, and/or the parts list.
2. When ordering, please include part number, part name, and quantity desired.
3. Please include your model name and machine serial number (located on the machine nameplate) with your order.
4. Address all parts orders to:

Parts Department  
Gold Medal Products Co.  
10700 Medallion Drive  
Cincinnati, Ohio 45241-4807

or, place orders at:

(513) 769-7676  
Fax: (513) 769-8500  
E-mail: [goldme19@eos.net](mailto:goldme19@eos.net)

## GENERAL SAFETY OPERATING TIPS WHEN USING A FOOTSWITCH

	<p style="text-align: center;"><b>▲ CAUTION</b></p> <p>Failure to use footswitch safely could result in personal injury. Footswitch should only be used where adequate guards or other safety devices are in place for those applications where the use of a footswitch could cause personal injury.</p>
	<p style="text-align: center;"><b>▲ WARNING</b></p> <p>Always use a grounded plug or cable. Do not cut off the ground prong and be sure to ground the footswitch with the ground screw provided.</p>

Follow the appropriate wiring and safety requirements as set forth in the American National Standards Institute (ANSI) and National Electrical Code (NEC) or other appropriate standards.

Use proper electrical circuits and circuit protection when wiring footswitch.

Disconnect power before servicing.

Do not leave footswitch out in aisles or in areas where they can be inadvertently stepped on.

Do not allow cord to rest on floor or in areas where it can be a tripping hazard or can be abused by heavy traffic.

Do not leave footswitch accessible to inadvertent operation when left unattended or when not being used.

Do not bypass any machine or equipment safety features with this footswitch.

Replace damaged cord immediately.

It is the responsibility of the user to determine the suitability of a foot control for the intended use.

It is the responsibility of the user to comply to federal, state and local safety and health regulations.

# SHAVER EXPLODED VIEW

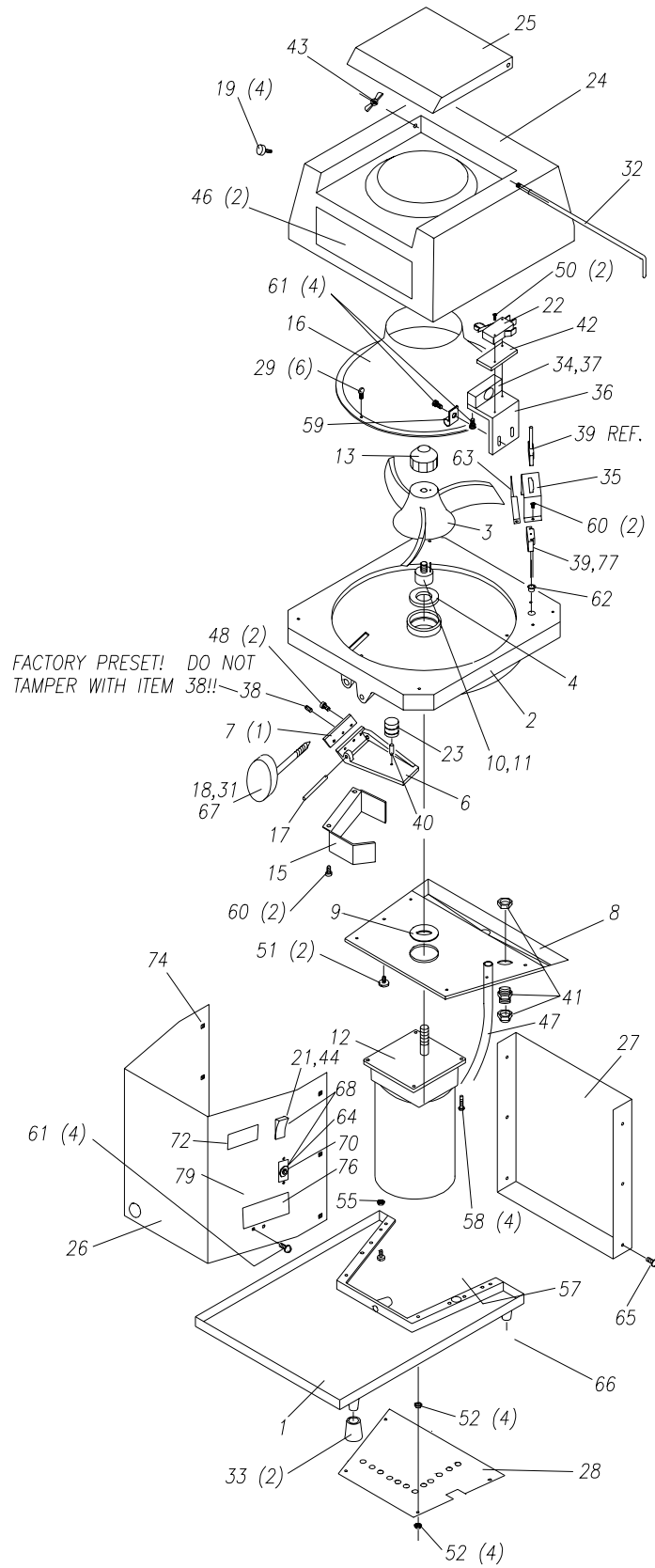

# PARTS LIST

#1047		
Item No	Part No	Description
1	12088	Base
2	12556	Upper Basin
3	12090	Impeller
4	12091	Ball Bearing
6	12195	Blade Holder
7	12263	Blade
8	12643	Drain Tray
9	12097	Water Sheild
10	12098	Pusher
11	12104	Pusher Stud
12	12194	Drive Motor
13	12106	Nut, Impeller
15	12274	Chute
16	12109	Hopper
17	12275	Pin
18	12111	Knob
19	12112	Knob, Cover
21	12115	Power Switch
22	12116	Door Switch
23	12273	Spring
24	12557	Top Cover
25	12119	Door
26	12551	Front Cover
27	12272	Back Cover
28	12294	Bottom Cover
29	12123	Thumb Screw, #10-32 x 3/8"
31	12125	Adjustment Screw
32	12277	Hinge Pin
33	12487	Rubber Foot (2)
34	12135	Mount Block
35	12146	Bracket
36	12136	Bracket
37	12078	1/2" Magnet
38	12129	#10 Set Screw, Factory Preset-Do Not Tamper With
39	12131	Harness
40	12143	Stud, Spring
41	12149	Srain Relief
42	12151	Spacer
43	12152	Wing Nut, #6-32
45	12154	Lead In Cord *
46	12155	Ice Decal
47	12156	Drain Tubing

\* Not Shown

## PARTS LIST

#1047		
Item No	Part No	Description
48	12158	Thumb Screw
49	12159	Drain Hose *
50	12186	Screw #4-40
51	12183	Screw 5/16-18
52	12187	Jam Nut, 5/16-18
53	49133	Dead End Splice *
54	12184	Washer, 5/16" *
57	76026	Strain Relief
58	12185	Screw, 1/4-20
59	84085	Cord Clip *
60	87341	Screw #8-32
61	89128	Screw #8-32
62	47236	Snap Bushing
63	12160	Water Sheild
65	12181	Mount Plate
66	12642	Suction Cup 1/4-20 Stud (2)
67	12165	Set Screw #8-32
68	12177	Tape, Super 33
69	12178	#10 Washer, S/S *
70	12182	Overload and Nut
71	79363	Tube Clamp *
72	12204	Label
76	12173	Warning Label
77	41415	1/4" Flag Terminal

\* Not Shown

# ELECTRICAL SCHEMATIC

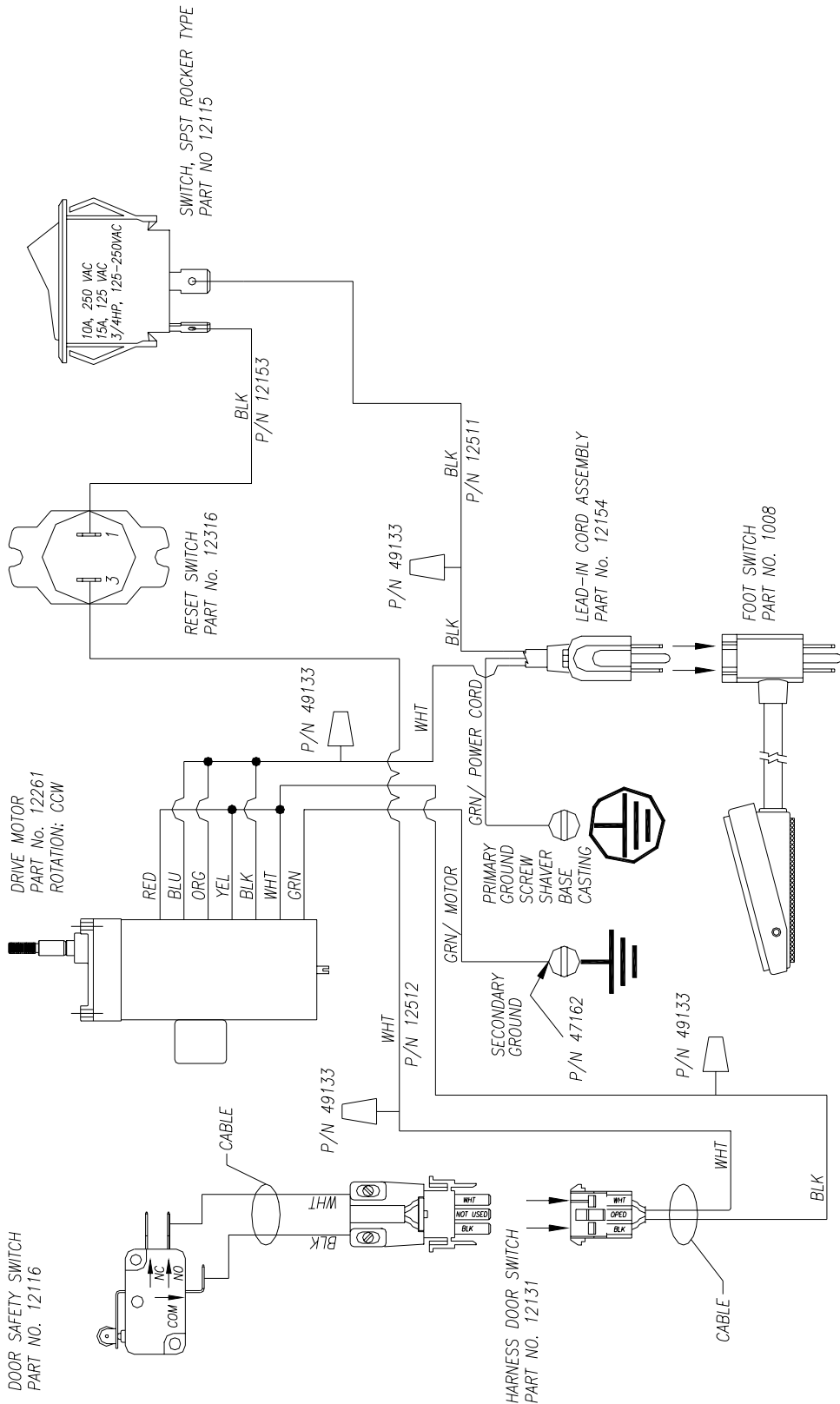

## WARRANTY

WE WARRANT to the original purchaser the Gold Medal equipment sold by us to be free from defects in material or workmanship under normal use and service. Our obligation under this warranty shall be limited to the repair or replacement of any defective part for a period of six (6) months from the date of sale to the Original Purchaser with regard to labor and one (1) year with regard to parts and does not cover damage to the equipment caused by accident, alteration, improper use, voltage, abuse, or failure to follow instructions.

THIS WARRANTY IS IN LIEU OF ALL OTHER WARRANTIES EXPRESSED OR IMPLIED, AND OF ALL OTHER OBLIGATIONS OR LIABILITIES ON OUR PART, INCLUDING THE IMPLIED WARRANTY OF MERCHANTABILITY. THERE ARE NO WARRANTIES WHICH EXTEND BEYOND THE DESCRIPTION ON THE FACE HEREOF. We neither assume, nor authorize any other person to assume for us, any other obligation or liability in connection with the sale of said GOLD MEDAL equipment or any part thereof.

The term "Original Purchaser" as used in this warranty shall be deemed to mean that person, firm, association, or corporation who was billed by the GOLD MEDAL PRODUCTS COMPANY, or their authorized distributor for the equipment.

THIS WARRANTY HAS NO EFFECT AND IS VOID UNLESS THE ORIGINAL PURCHASER FIRST CALLS GOLD MEDAL PRODUCTS COMPANY AT 1-800-543-0862 TO DISCUSS WITH OUR SERVICE REPRESENTATIVE THE EQUIPMENT PROBLEM, AND, IF NECESSARY, FOR INSTRUCTIONS CONCERNING THE REPAIR OR REPLACEMENT OF PARTS.

*NOTE: This equipment is manufactured and sold for commercial use only.*



**GOLD MEDAL PRODUCTS COMPANY**  
**10700 Medallion Drive**  
**Cincinnati, Ohio 45241-4807 USA**